

PLAN D'IMPLANTATION DES POTEAUX ET MUR OSSATURE BOIS RDC échelle 1/50e

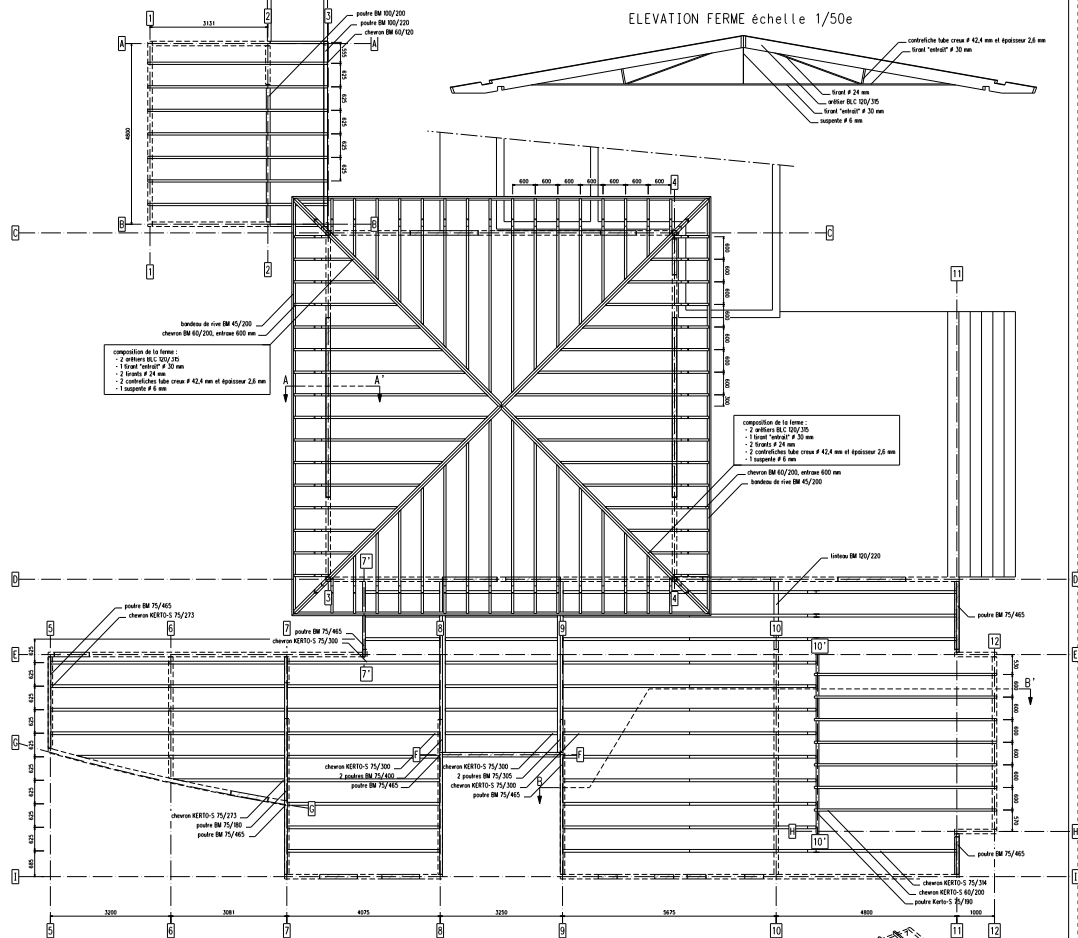

PLAN DE CHARPENTE échelle 1/50e

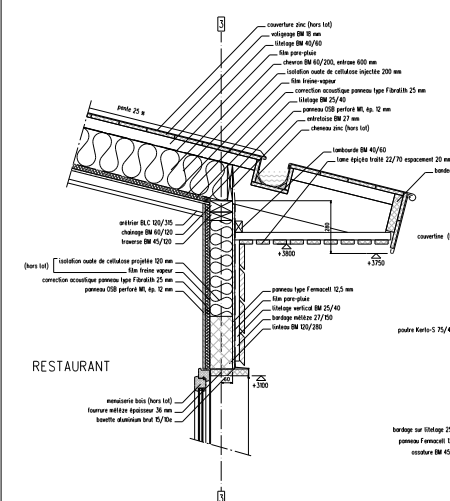

COUPE VERTICALE DE PRINCIPE BB' échelle 1/10e

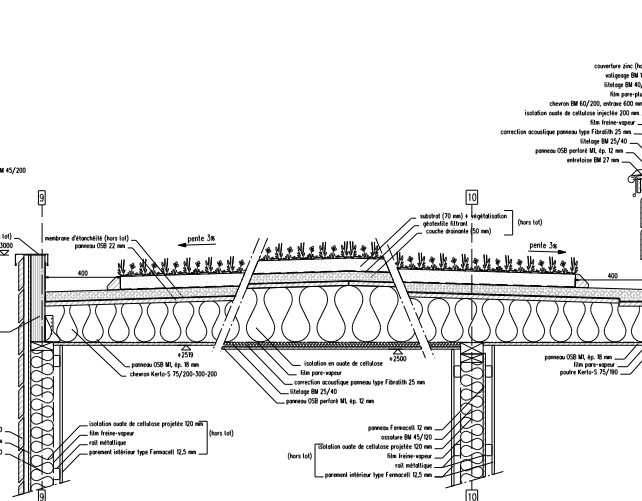

COUPE VERTICALE DE PRINCIPE AA' échelle 1/10e

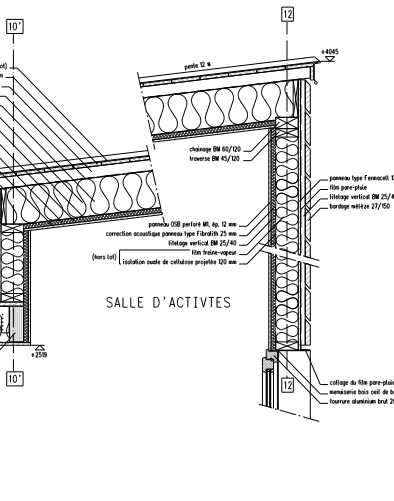

SALLE D'ACTIVITES

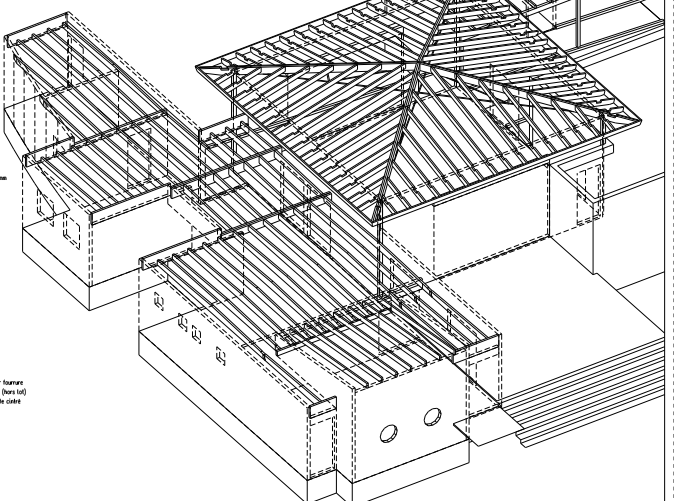

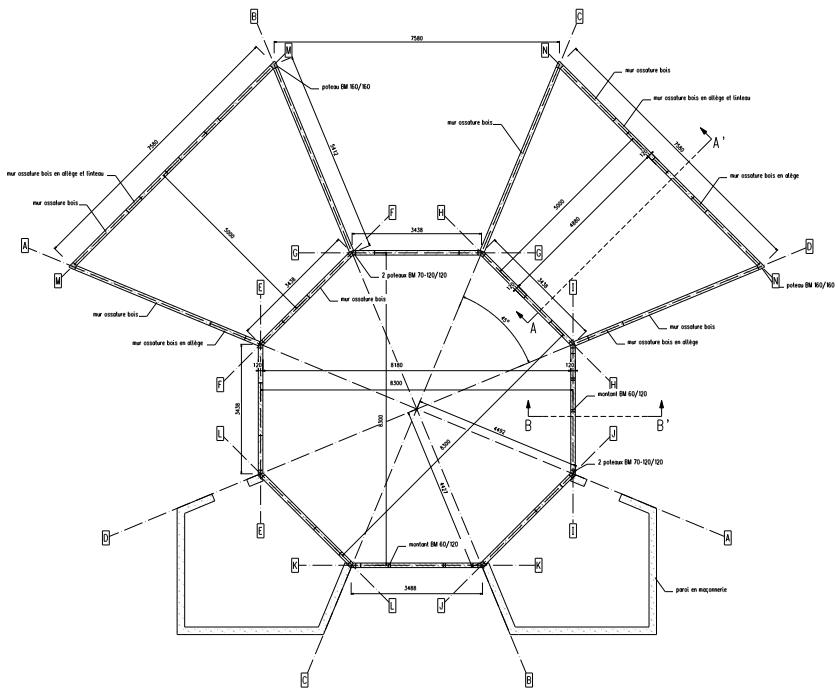

PLAN D'IMPLANTATION DES MURS A OSSATURE BOIS ET DES POTEAUX PORTEURS échelle 1/50e

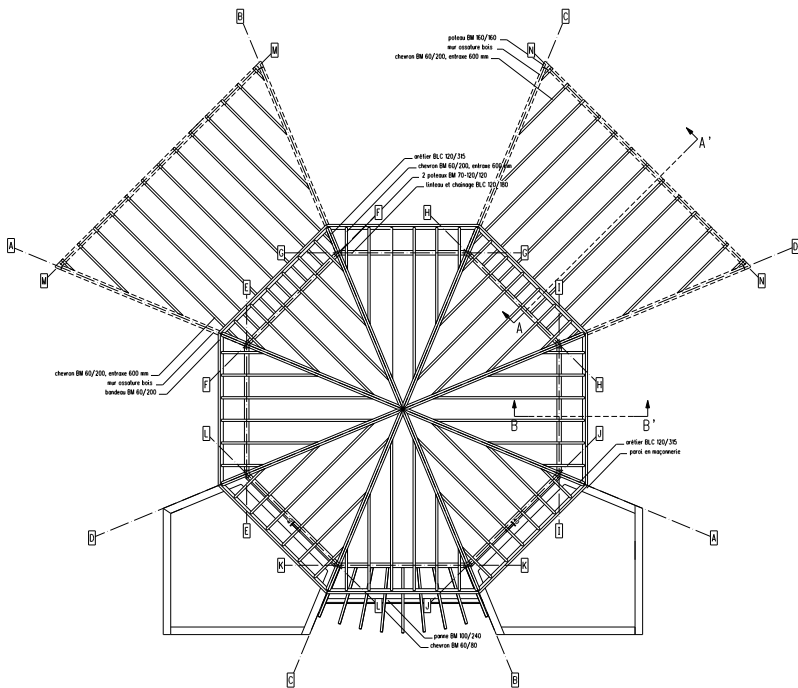

PLAN DE CHARPENTE échelle 1/50e

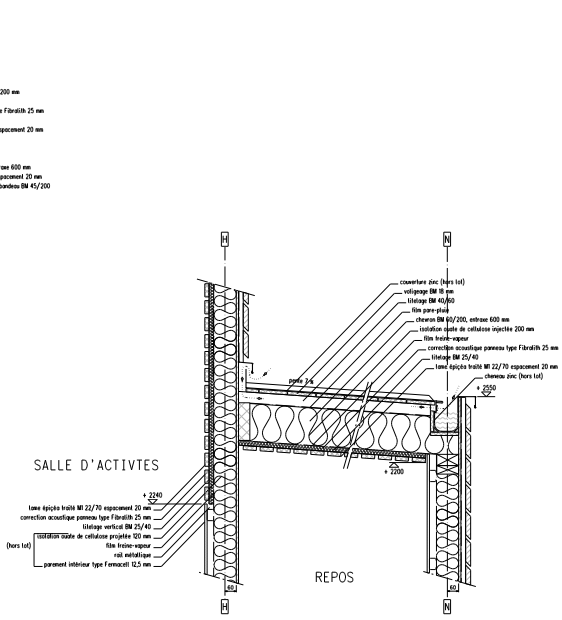
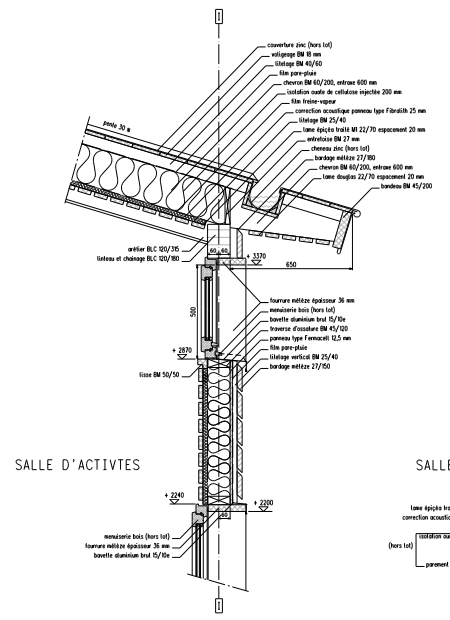

COUPE VERTICALE DE PRINCIPE BB' échelle 1/10e

COUPE VERTICALE DE PRINCIPE AA' échelle 1/10e

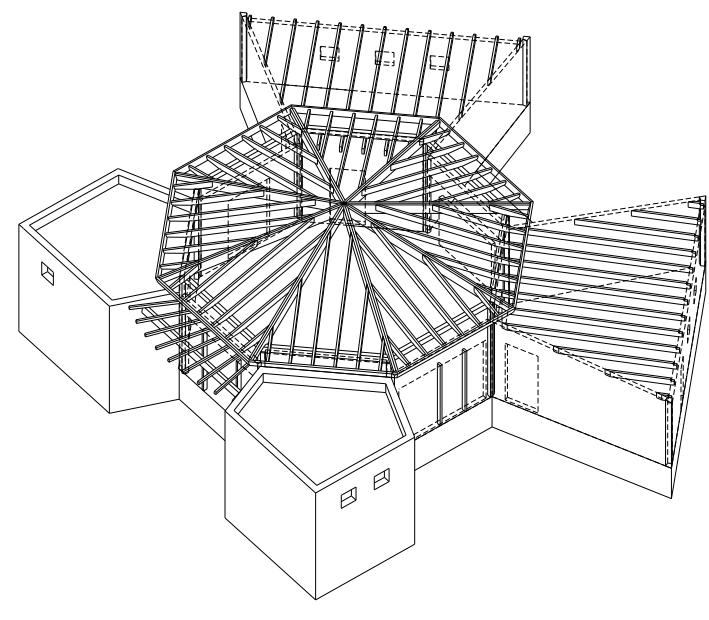

VUE AXONOMETRIQUE DE LA STRUCTURE DE LA CHARPENTE

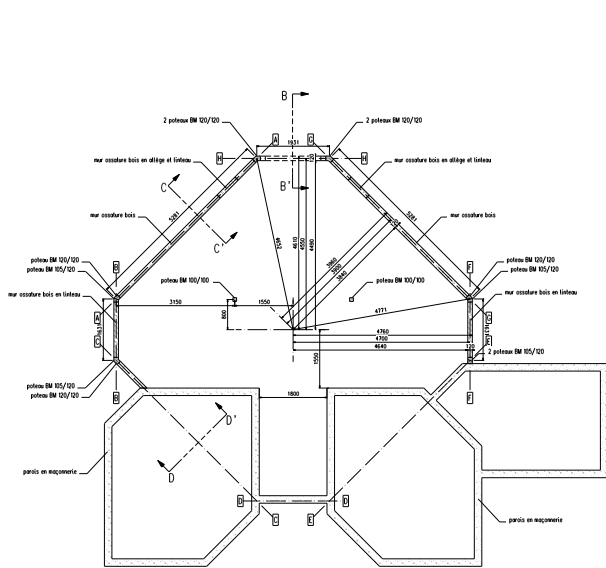

PLAN D'IMPLANTATION DE POTEAUX ET MUR OSSATURE BOIS RDC échelle 1/50e

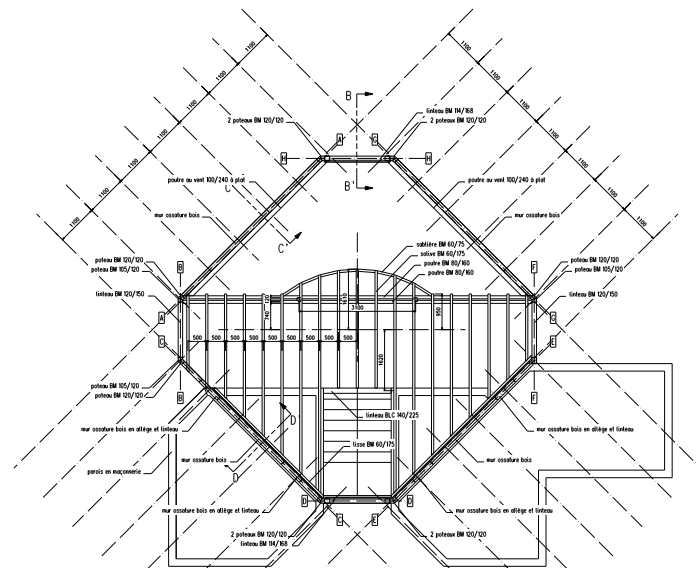

PLAN D'IMPLANTATION DE POTEAUX, MUR OSSATURE BOIS ET STRUCTURE R+1 échelle 1/50e

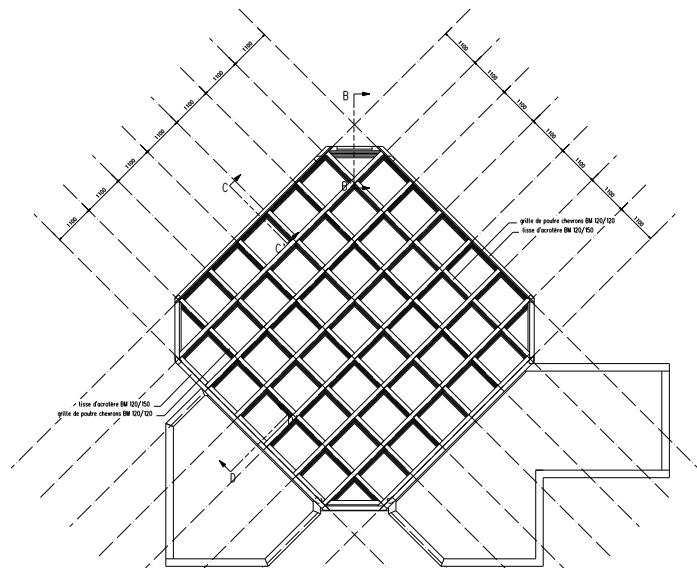

PLAN DE CHARPENTE échelle 1/50e

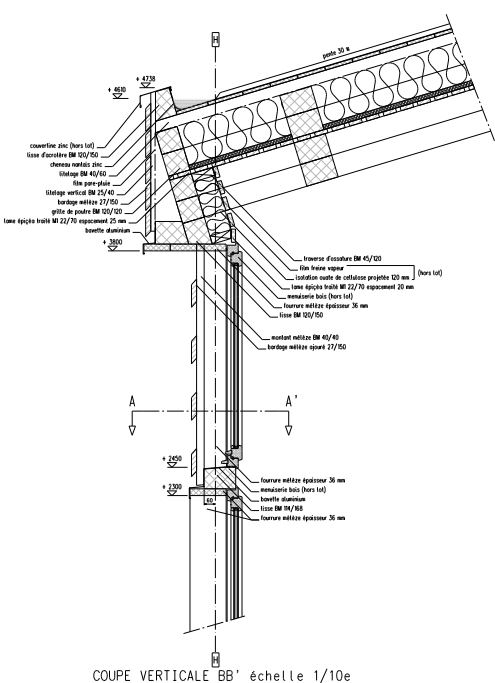

COUPE VERTICALE BB' échelle 1/10e

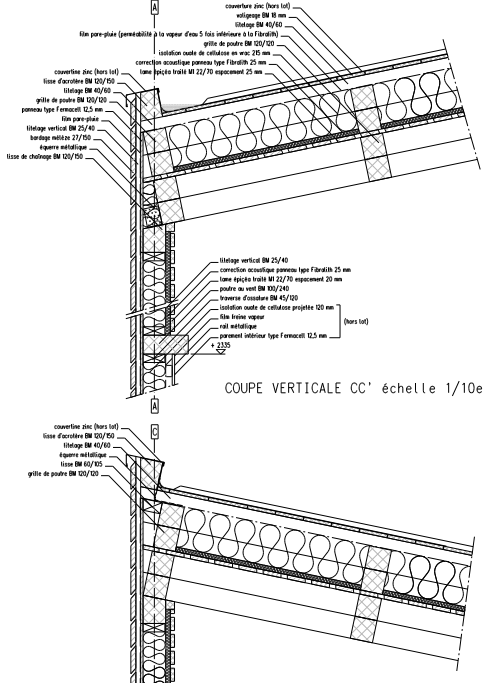

COUPE VERTICALE CC' échelle 1/10e

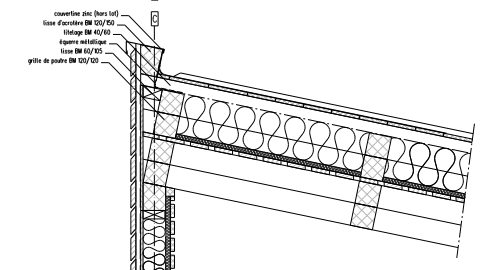

COUPE VERTICALE DD' échelle 1/10e

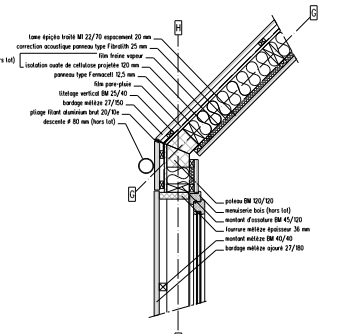

COUPE HORIZONTALE AA' échelle 1/10e

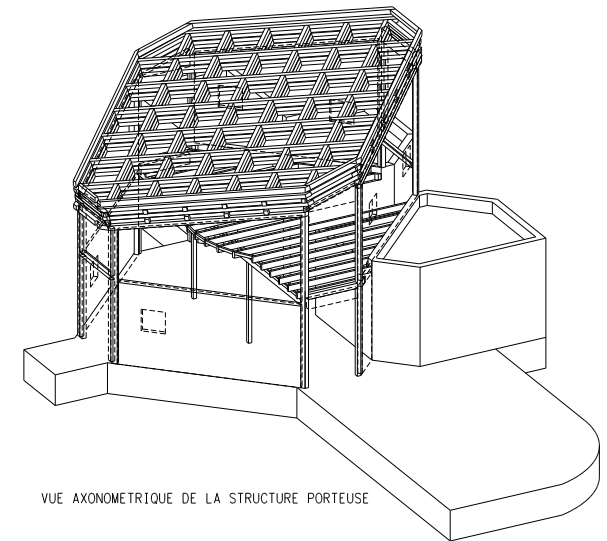

VUE AXONOMETRIQUE DE LA STRUCTURE PORTEUSE